

Approval body for construction products
and types of construction

Bautechnisches Prüfamt

An institution established by the Federal and
Laender Governments



European Technical Assessment

ETA-05/0070
of 12 May 2015

English translation prepared by DIBt - Original version in German language

General Part

Technical Assessment Body issuing the
European Technical Assessment:

Deutsches Institut für Bautechnik

Trade name of the construction product

mungo Throughbolt m2, m2-C, m2-CG

Product family
to which the construction product belongs

Torque-controlled expansion anchor made of galvanised
steel of sizes M6, M8, M10, M12, M16 an M20 for use in
non-cracked concrete

Manufacturer

Mungo Befestigungstechnik AG
Bornfeldstrasse 2
4603 Olten
SCHWEIZ

Manufacturing plant

Mungo Werk Olten

This European Technical Assessment
contains

14 pages including 3 annexes

This European Technical Assessment is
issued in accordance with Regulation (EU)
No 305/2011, on the basis of

Guideline for European technical approval of "Metal
anchors for use in concrete", ETAG 001 Part 2: "Torque
controlled expansion anchors", April 2013,
used as European Assessment Document (EAD)
according to Article 66 Paragraph 3 of Regulation (EU)
No 305/2011.

European Technical Assessment

ETA-05/0070

English translation prepared by DIBt

Page 2 of 14 | 12 May 2015

The European Technical Assessment is issued by the Technical Assessment Body in its official language. Translations of this European Technical Assessment in other languages shall fully correspond to the original issued document and shall be identified as such.

Communication of this European Technical Assessment, including transmission by electronic means, shall be in full. However, partial reproduction may only be made with the written consent of the issuing Technical Assessment Body. Any partial reproduction has to be identified as such.

This European Technical Assessment may be withdrawn by the issuing Technical Assessment Body, in particular pursuant to information by the Commission according to Article 25 Paragraph 3 of Regulation (EU) No 305/2011.

Specific Part

1 Technical description of the product

The mungo m2 is an anchor made of galvanised steel which is placed into a drilled hole and anchored by torque-controlled expansion. According to the size of washer the anchor versions are designated as m2, m2-C and m2-CG.

The product description is given in Annex A.

2 Specification of the intended use in accordance with the applicable European Assessment Document

The performances given in Section 3 are only valid if the anchor is used in compliance with the specifications and conditions given in Annex B.

The verifications and assessment methods on which this European Technical Assessment is based lead to the assumption of a working life of the anchor of at least 50 years. The indications given on the working life cannot be interpreted as a guarantee given by the producer, but are to be regarded only as a means for choosing the right products in relation to the expected economically reasonable working life of the works.

3 Performance of the product and references to the methods used for its assessment

3.1 Mechanical resistance and stability (BWR 1)

Essential characteristic	Performance
Characteristic resistance for static and quasi static action for design according to ETAG 001 Annex C and displacements	See Annex C 1 and C 2

3.2 Safety in case of fire (BWR 2)

Essential characteristic	Performance
Reaction to fire	Anchorage satisfy requirements for Class A1
Characteristic resistance under fire exposure	See Annex C 3 and C 4

3.3 Hygiene, health and the environment (BWR 3)

Not applicable.

3.4 Safety in use (BWR 4)

The essential characteristics regarding Safety in use are included under the Basic Works Requirement Mechanical resistance and stability.

3.5 Protection against noise (BWR 5)

Not applicable.

3.6 Energy economy and heat retention (BWR 6)

Not applicable.

3.7 Sustainable use of natural resources (BWR 7)

The sustainable use of natural resources was not investigated.

3.8 General aspects

The verification of durability is part of testing the essential characteristics. Durability is only ensured if the specifications of intended use according to Annex B are taken into account.

4 Assessment and verification of constancy of performance (AVCP) system applied, with reference to its legal base

According to Decision of the Commission of 24 June 1996 (96/582/EC) (OJ L 254 of 08.10.96 p. 62-65), the system of assessment and verification of constancy of performance (see Annex V and Article 65 Paragraph 2 to Regulation (EU) No 305/2011) given in the following table applies.

Product	Intended use	Level or class	System
Metal anchors for use in concrete (heavy-duty type)	For fixing and/or supporting concrete structural elements or heavy units such as cladding and suspended ceilings	—	1

5 Technical details necessary for the implementation of the AVCP system, as provided for in the applicable European Assessment Document

Technical details necessary for the implementation of the AVCP system are laid down in the control plan deposited at Deutsches Institut für Bautechnik.

Issued in Berlin on 12 May 2015 by Deutsches Institut für Bautechnik

Uwe Bender
Head of Department

beglaubigt:
Lange

Installed anchor

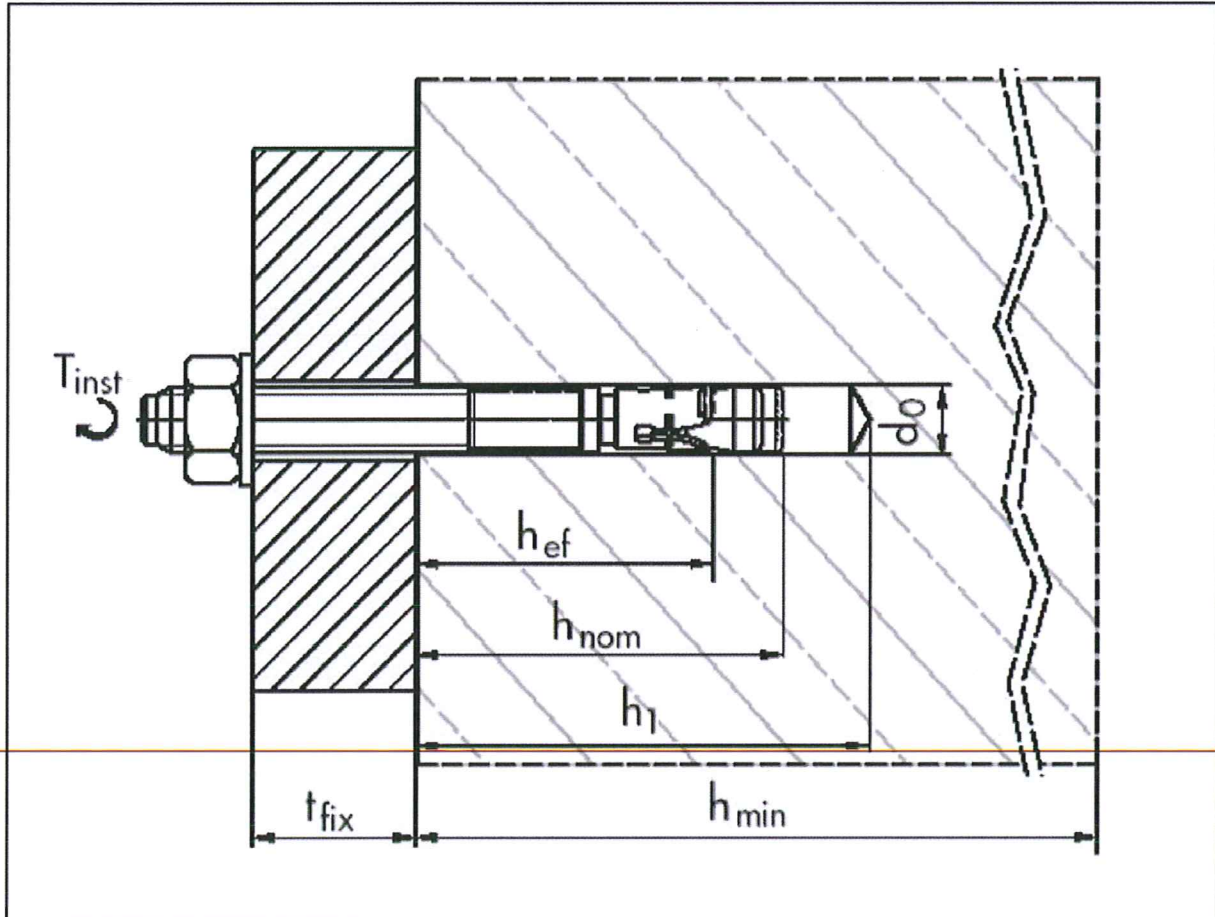

- Legend:
- h_{ef} = effective anchorage depth
 - h_{nom} = embedment depth
 - h_1 = depth of drill hole
 - h_{min} = minimum thickness of concrete member
 - d_0 = nominal diameter of drill bit
 - t_{fix} = thickness of fixture
 - T_{inst} = installation torque

m2, m2-C, m2-CG

Product description
Installed condition

Annex A 1

Anchor type

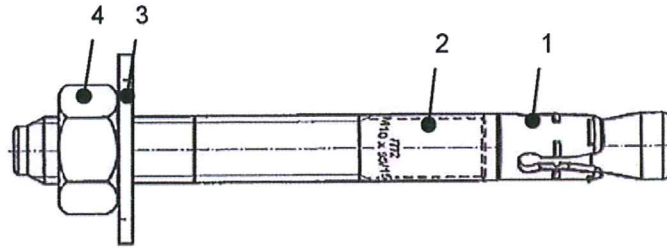

- 1 expansion element
- 2 bolt
- 3 washer
- 4 hexagonal nut

Gestaltung Spreizbleche:



m2 M6
m2 M16 Typ A
m2 M20



m2 M8
m2 M10
m2 M12



m2 M16 Typ B

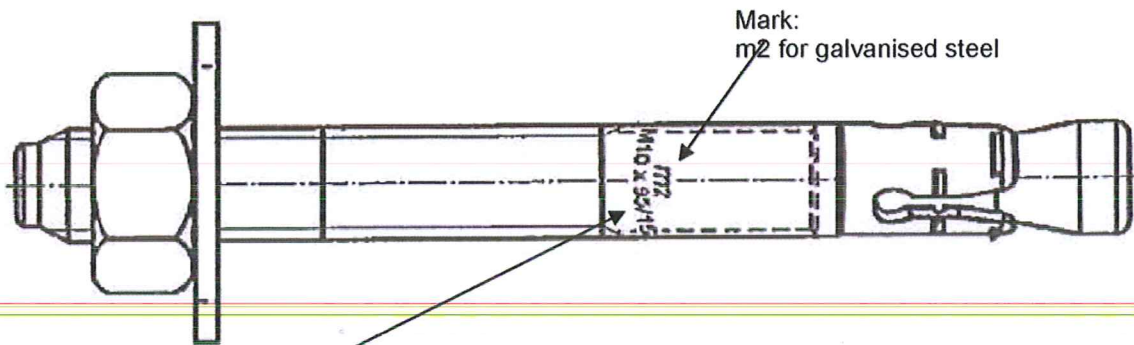

Reading:
Nominal diameter (e.g. M10) x anchor length (e.g. 95) x max. member thickness (e.g. 15)

Anchor types:

- m2 bolt m2 with washer EN ISO 7089:2000 and hexagonal nut DIN 934:1987-10
- m2-C bolt m2 with washer EN ISO 7093-1:2000 and hexagonal nut DIN 934:1987-10
- m2-CG bolt m2 with washer EN ISO 7094:2000 and hexagonal nut DIN 934:1987-10

m2, m2-C, m2-CG

Product description
Marking and denomination

Annex A 2

Table A1: Dimensions

Part	Designation		M6	M8	M10	M12	M16	M20	
1	Bolt	d_k [mm]	6	8	10	12	16	20	
		d_h [mm]	4	5,6	7,2	8,5	11,5	15,2	
		d_{s1} [mm]	5,25	7,05	8,9	10,7	14,5	-	
		d_{s2} [mm]	-	-	-	12	16	20	
		min l_G [mm]	19	43	23	32	33	70	
		max l_G [mm]	62	120	120	120	120	120	
		min L [mm]	50	80	95	80	90	130	
		max L [mm]	95	165	180	360	440	270	
2	Expansion element	type A	l_s [mm]	9,5	13,2	15,2	17,5	19,3	21,6
		type B		-	-	-	-	19,7	-
3	Washer	EN ISO 7089:2000	d_u [mm]	12	16	20	24	30	37
			s [mm]	1,6	1,6	2	2,5	3	3
		EN ISO 7093-1:2000	d_u [mm]	18	24	30	37	50	60
			s [mm]	1,6	2	2,5	3	3	4
		EN ISO 7094:2000	d_u [mm]	22	28	34	44	56	72
			s [mm]	2	3	3	4	5	6
4	Hexagonal nut	SW	[mm]	10	13	17	19	24	30

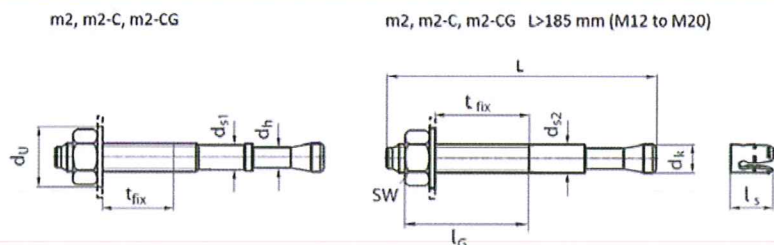

Table A2: Materials

Part	Designation		Material
1	Bolt	$L \leq 185$ mm	cold forged steel EN10263-2:2001, electroplated $\geq 5 \mu\text{m}$
		$L > 185$ mm ¹⁾	free-cutting steel EN 10087:1998, electroplated $\geq 5 \mu\text{m}$
2	Expansion element	$L \leq 185$ mm	cold rolled steel strip EN10139:1997, electroplated $\geq 5 \mu\text{m}$
		$L > 185$ mm ¹⁾	cold rolled stainless steel strip EN10088-2:2014, no coating
3	Washer		cold rolled steel strip EN10139:1997, electroplated $\geq 5 \mu\text{m}$
4	Hexagonal nut		steel, property class 8, DIN 934:1987-10, electroplated $\geq 5 \mu\text{m}$

¹⁾ valid for sizes M12 and M16, valid for size M20 independent of length

m2, m2-C, m2-CG

Product description
Dimensions and materials

Annex A 3

Specifications of intended use

Anchorage subject to:

- Static and quasi-static loads
- Fire exposure

Base materials:

- Reinforced or unreinforced normal weight concrete according to EN 206:2013
- Strength classes C20/25 to C50/60 according to EN 206:2013
- Non-cracked concrete

Use conditions:

- Structures subject to dry internal conditions (zinc coated steel)

Design:

- Anchorages are designed under the responsibility of an engineer experienced in anchorages and concrete work.
- Verifiable calculation notes and drawings are prepared taking account of the loads to be anchored. The position of the anchor is indicated on the design drawings (e. g. position of the anchor relative to reinforcement or to supports, etc.).
- Anchorages under static or quasi-static actions are designed in accordance with ETAG 001, Annex C, design method A, Edition August 2010
- Anchorages under fire exposure are designed in accordance with EOTA Technical Report TR 020, Edition May 2004
- It must be ensured that local spalling of the concrete cover does not occur.

Installation:

- Hole drilling by hammer drilling only
- Anchor installation in accordance with the manufacturer's specifications using the appropriate tools carried out by appropriately qualified personnel and under the supervision of the person responsible for technical matters of the site.
- Use of the anchor only as supplied by the manufacturer without exchanging the components of an anchor
- Check concrete strength before placing the anchor to ensure that the strength class of the concrete is covered by the product's assessment
- Positioning the drill holes without damaging the reinforcement
- Cleaning the holes
- Edge distances and spacing not less than the specified values without minus tolerances
- Anchor installation such that the effective embedment depth is complied with. This compliance is ensured if the anchor's embedment mark doesn't exceed the concrete surface.
- The anchor may only be set once.
- In case of aborted holes: new drilling at a minimum distance away of twice the depth of the aborted hole or smaller distance if the aborted hole is filled with high strength mortar and if under shear or oblique tension load it isn't in the direction of load application.
- Using a calibrated torque wrench for installation.

m2, m2-C, m2-CG

**Intended use
Specifications**

Annex B 1

Table B1: Installation parameters

Anchor size			M6	M8	M10	M12	M16	M20
Nominal drill hole diameter	d_0	[mm]	6	8	10	12	16	20
Effective anchorage depth	h_{ef}	[mm]	40	50	58	68	80	100
Installation torque	T_{inst}	[Nm]	5	15	30	50	100	200
Cutting diameter at the upper tolerance limit (maximum diameter bit)	$d_{cut,max}$	[mm]	6,4	8,45	10,45	12,5	16,5	20,55
Depth of drill hole	h_1	[mm]	60	70	80	90	110	130
Diameter of clearance hole in fixture	d_f	[mm]	7	9	12	14	18	22
Minimum fixture thickness	$t_{fix,min}$	[mm]	1	1	1	1	1	1
Maximum fixture thickness	$t_{fix,max}$	[mm]	25	95	130	265	325	140

Table B2: minimum thickness of concrete member, minimum spacing and edge distances

Size			M6	M8	M10	M12		M16		M20
Anchor length	L	[mm]				≤ 185	> 185	≤ 185	> 185	
Minimum thickness of concrete member	h_{min}	[mm]	100	100	120	140		160		200
Minimum spacing for edge distance	s_{min}	[mm]	40	45	50	75	110	100	120	200
	c	[mm]	70	45	50	80	200	190	320	400
Minimum edge distance for spacing	c_{min}	[mm]	40	-	-	-	150	130	240	300
	s	[mm]	80	-	-	-	210	190	240	350

m2, m2-C, m2-CG

Intended use
Installation parameters
Minimum thickness of concrete member, minimum spacing and edge distances

Annex B 2

Installation instructions

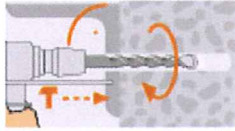

Drilling the hole

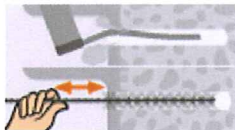

Cleaning the hole

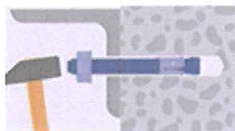

Fixing plug and building material



Tightening with torque wrench and predetermined value of T_{inst}

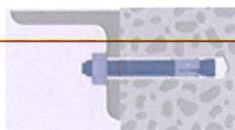

Tightened fixation

m2, m2-C, m2-CG

Intended use
Installation instructions

Annex B 3

Table C1: Design method A, characteristic values under tension load

Anchor size			M6	M8 ²⁾	M10 ²⁾	M12 ²⁾		M16	M20
Anchor length	L	[mm]				≤ 185	> 185		
Installation safety factor	γ_2	[-]	1,0			1,2			
Steel failure									
Characteristic resistance	$N_{Rk,s}$	[kN]	10	19	33	43	43	77	124
Partial safety factor	γ_{Ms} ¹⁾	[-]	1,4						
Pull-out failure									
Characteristic resistance	$N_{Rk,p}$	[kN]	7,5	12	16	25	25	30	50
Increasing factor for $N_{Rk,p}$	ψ_c	C30/37	1,17						
		C40/50	1,32						
		C50/60	1,42						
Concrete cone failure									
Effective anchorage depth	h_{ef}	[mm]	40	50	58	68	80	100	
Spacing	$s_{Cr,N}$	[mm]	120	150	175	205	240	300	
Edge distance	$c_{Cr,N}$	[mm]	60	75	87	102	120	150	
Concrete splitting failure									
Spacing	$s_{Cr,sp}$	[mm]	200	250	290	340	400	500	
Edge distance	$c_{Cr,sp}$	[mm]	100	125	145	170	200	250	

¹⁾ In absence of other national regulations.

²⁾ valid for clip in annex A2

Table C2: Displacements under tension load

Anchor size			M6	M8	M10	M12	M16	M20
Tension load	N	[kN]	3,6	5,7	7,6	9,9	11,9	19,8
Displacement	δ_{N0}	[mm]	0,3					
	$\delta_{N\infty}$	[mm]	1,3					

m2, m2-C, m2-CG

Performances

Design method A, characteristic values under tension load
Displacements under tension load

Annex C 1

Table C3: Design method A, characteristic values under shear load

Anchor size			M6	M8 ²⁾	M10 ²⁾	M12 ²⁾		M16	M20
Anchor length	L	[mm]				≤ 185	> 185		
Steel failure without lever arm									
Characteristic resistance	$V_{Rk,s}$	[kN]	4,5	11	18	24	28	33	51
Partial safety factor	γ_{Ms} ¹⁾	[-]	1,5	1,29	1,27	1,25	1,33	1,5	
Steel failure with lever arm									
Characteristic resistance	$M_{Rk,s}^0$	[Nm]	12,0	27	56,8	91,6	104,7	249	486,2
Partial safety factor	γ_{Ms} ¹⁾	[-]	1,5	1,29	1,27	1,25	1,33	1,5	
Concrete pryout failure									
Factor in equation (5.6) of ETAG Annex C 5.2.3.3	k	[-]	1,0			2,0			
Concrete edge failure									
Effective anchor length under shear load	l_f	[mm]	40	50	58	68		80	100
external anchor diameter	d_{nom}	[mm]	6	8	10	12		16	20

¹⁾ In absence of other national regulations.

²⁾ valid for clip in annex A2

Table C4: Displacements under shear load

Anchor size		M6	M8	M10	M12	M16	M20
Shear load	[kN]	1,9	3,5	5,5	7,5	14	21,9
Displacement	δ_{VO}	1,6	2,2	2,4	2,7	3,3	3,8
	$\delta_{V\infty}$	2,4	3,2	3,6	4,1	4,9	5,7

m2, m2-C, m2-CG

Performances

Design method A, characteristic values under shear load
Displacements under shear load

Annex C 2

Table C5: Characteristic tension resistance under fire exposure in uncracked concrete C20/25 to C50/60: Design method A according to ETAG 001, Annex C

Anchor size			M6	M8	M10	M12		M16		M20	
Anchor length	L	[mm]				≤ 185	> 185	≤ 185	> 185		
Partial safety factor	$\gamma_{M,fi}^{1)}$	[-]	1,0								
Steel failure											
Characteristic resistance	R30	$N_{Rk,s,fi}$	[kN]	0,13	0,25	0,6	1,1	1,1	2,1	2,1	3,6
	R60	$N_{Rk,s,fi}$	[kN]	0,11	0,22	0,5	0,9	0,9	1,6	1,6	2,7
	R90	$N_{Rk,s,fi}$	[kN]	0,09	0,17	0,41	0,7	0,7	1,4	1,4	2,4
	R120	$N_{Rk,s,fi}$	[kN]	0,06	0,12	0,33	0,6	0,6	1,0	1,0	1,8
Pull-out failure											
Characteristic resistance in concrete ≥ C20/25	R30	$N_{Rk,p,fi}$	[kN]	1,9	3,0	4,0	6,3	6,3	7,5	7,5	12,5
	R60										
	R90										
	R120	$N_{Rk,p,fi}$	[kN]	1,5	2,4	3,2	5,0	5,0	6,0	6,0	10,0
Concrete cone failure											
Characteristic resistance in concrete ≥ C20/25	R30	$N_{Rk,c,fi}^0$	[kN]	1,8	3,2	4,6	6,9	6,9	10,3	10,3	18,0
	R60										
	R90										
	R120	$N_{Rk,c,fi}^0$	[kN]	1,5	2,5	3,7	5,5	5,5	8,2	8,2	14,4
Embedment depth	h_{ef}	[mm]	40	50	58	68	68	80	80	100	
Minimum member thickness	h_{min}	[mm]	100	100	120	140	140	160	160	200	
Spacing	$s_{Cr,N,fi}$	[mm]	4* h_{ef}								
	s_{min}	[mm]	40	45	50	75	110	100	120	200	
Edge distance	$c_{Cr,N,fi}$	[mm]	2* h_{ef}								
	c_{min}	[mm]	80	100	120	140	140	200	320	400	
Fire exposure from one side only			≥ 300 mm						320	400	
Fire exposure from more than one side			≥ 300 mm						320	400	

m2, m2-C, m2-CG

Performances

Characteristic tension resistance under fire exposure: Design method A, according to ETAG 001, Annex C

Annex C 3

Table C6: Characteristic shear resistance under fire exposure in uncracked concrete C20/25 to C50/60: Design method A according to ETAG 001, Annex C

Anchor size			M6	M8	M10	M12		M16		M20	
Anchor length	L	[mm]				≤ 185	> 185	≤ 185	> 185		
Partial safety factor	$\gamma_{M,fi}$ ¹⁾	[-]	1,0								
Steel failure without lever arm											
Characteristic resistance	R30	$V_{RK,s,fi}$	[kN]	0,20	0,37	0,9	1,7	1,7	3,1	3,1	4,9
	R60	$V_{RK,s,fi}$	[kN]	0,18	0,33	0,8	1,3	1,3	2,3	2,3	3,7
	R90	$V_{RK,s,fi}$	[kN]	0,14	0,26	0,6	1,1	1,1	2,0	2,0	3,2
	R120	$V_{RK,s,fi}$	[kN]	0,10	0,18	0,46	0,8	0,8	1,6	1,6	2,4
Steel failure with lever arm											
Characteristic resistance	R30	$M^0_{RK,s,fi}$	[kN]	0,08	0,21	0,7	1,4	1,4	3,6	3,6	8,3
	R60	$M^0_{RK,s,fi}$	[kN]	0,07	0,19	0,6	1,1	1,1	2,7	2,7	6,2
	R90	$M^0_{RK,s,fi}$	[kN]	0,05	0,14	0,44	0,9	0,9	2,3	2,3	5,4
	R120	$M^0_{RK,s,fi}$	[kN]	0,04	0,10	0,35	0,7	0,7	1,8	1,8	4,1
Steel failure with lever arm											
Factor in equation (5.6) of ETAG 001, Ann. C, 5.2.3.3	k	[-]	1,0	1,0	2,0	2,0	2,0	2,0	2,0	2,0	
Characteristic resistance	R30	$V_{RK,cp,fi}$	[kN]	1,8	3,2	9,2	13,7	13,7	20,6	20,6	36,0
	R60										
	R90	$V_{RK,ep,fi}$	[kN]	1,5	2,5	7,4	11	11	16,5	16,5	28,8
	R120										
Steel failure with lever arm											
The initial value $V^0_{RK,c,fi}$ of the characteristic resistance in concrete C20/25 to C50/60 under fire exposure may be determined by the following equations with $V^0_{RK,c}$ initial value of the characteristic resistance in concrete C20/25:											
	≤ R90	$V_{RK,c,fi}$	[kN]	$V^0_{RK,c,fi} = 0,25 * V^0_{RK,c}$							
	R120	$V_{RK,c,fi}$	[kN]	$V^0_{RK,c,fi} = 0,20 * V^0_{RK,c}$							

¹⁾ In absence of other national regulations.

m2, m2-C, m2-CG

Performances

Characteristic shear resistance under fire exposure: Design method A, according to ETAG 001, Annex C

Annex C 4